

KN
KFC-1679ie



TEMPLATE GABARIT SCHABLONE SJABLOON MASCHERINA PLANTILLA

DOOR/REAR DECK SPEAKER
HAUT-PARLEUR POUR PORTIÈRE/PLAGE ARRIÈRE

KFC-1679ie

INSTALLATION INSTRUCTIONS
PROCÉDURES D'INSTALLATION

Speaker locations
Emplacement des haut-parleurs
Plazierung der Lautsprecher
Locatie van Luidsprekers
Luogo di installazione degli altoparlanti
Ubicación de los altavoces

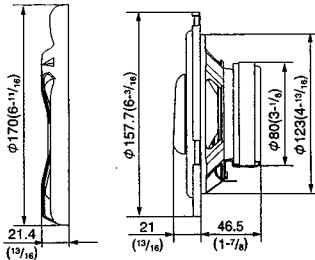
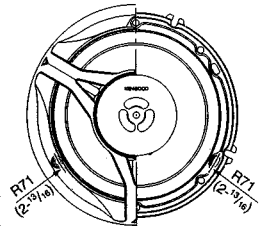
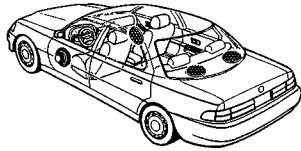

Dimensions
Abmessungen
Dimensioni

Dimensions
Afmetingen
Dimensiones

Unit: mm (inch)
Unité: mm (pouces)

Ø 126

R71

Ø 4.5

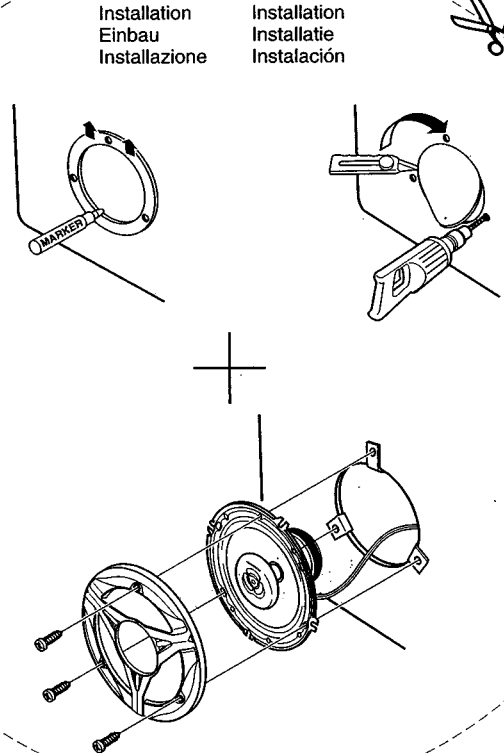

Connections
Anschlüsse
Collegamenti

Raccordements
Aansluitingen
Conexiones



Left
Gauche
Links
Linker
Sinistro
Izquierdo

Right
Droite
Rechts
Rechter
Destro
Derecho

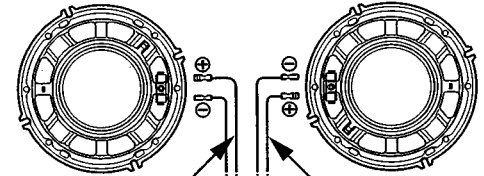

Gray/blue stripe
Câble strié bleu
Gau/Blau markiertes kabel
Grijs/blauw gestreept
Striscia grigia/bleu
Raya gris/azul

Gray/red stripe
Câble strié rouge
Gau/Rot markiertes kabel
Grijs/rood gestreept
Striscia grigia/rossa
Raya gris/roja

CAR AUDIO COMPONENTS
ELEMENTS HI-FI POUR VOITURE
AUTO STEREO-KOMPONENTEN
COMPONENTI AUDIO PER AUTO
COMPONENTES DE AUDIO PARA AUTOMÓVILES

Parts included
Mitgeliefertes zubehör
Parti incluse

Pieces comprises
Bijgeleverde onderdelen
Partes incluidas

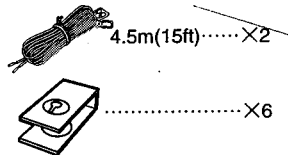
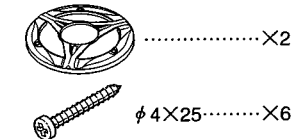

- Do not use the provided speaker cords for other purposes (such as a power cord). Otherwise malfunction or fire hazard could result.
- Ne pas utiliser les cordons de liaison aux enceintes pour une destination autre que celle prévue (par exemple, pour alimenter un appareil). Faute de quoi, un défaut de fonctionnement ou un incendie pourraient en résulter.
- Die mitgelieferten Lautsprecherkabel dürfen nicht für andere Zwecke verwendet werden (z.B. als Netzkabel), da dies eine Funktionsstörung oder die Gefahr eines Brandes verursacht.
- Gebruik de bijgeleverde luidsprekersnoeren niet voor andere doeleinden (bijvoorbeeld als netsnoer), daar dat mogelijk brand of andere problemen veroorzaakt.
- Non utilizzare i cavi dei diffusori in dotazione per scopi diversi (come, ad esempio, cavi di alimentazione). In caso contrario si possono causare incendi e folgorazioni.
- No utilice los cables de altavoces suministrados para otros propósitos (tales como los de un cable de alimentación). Si no, podrían producirse averías o peligros de incendio.

KENWOOD CORPORATION
TOKYO 192-8525 JAPAN

DESIGNED AND ENGINEERED IN JAPAN
MADE IN INDONESIA / FABRIQUE EN INDONESIE

VOLUME 0.0100m³/0.35ft³ WEIGHT/POIDS 2.0kg/4.4lb

IMPORTANT SAFEGUARDS

KENWOOD

KENWOOD CORPORATION

⚠ Caution : Read this page carefully to keep your safety.

©PRINTED IN SINGAPORE B58-0467-00(W/FS) 017595
90/12 11 10 9 8 7 6 5 4 3 2 1 89/12 11 10

Please read all of the safety and operating instructions before operating this unit. For best results, follow all warnings placed on the unit and adhere to the operating and use instructions. These safety and operating instructions should be retained for future reference.

1. Suffocation — After taking the unit out of the polyethylene bag, be sure to dispose of the polyethylene bag out of the reach of children. Otherwise, they may play with the bag, which could cause hazard of suffocation.

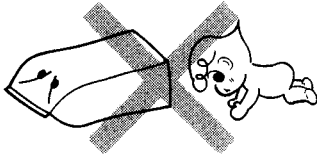

2. Power supply voltage — Connect the illumination lamp-equipped speakers to DC 12 V, negative ground.

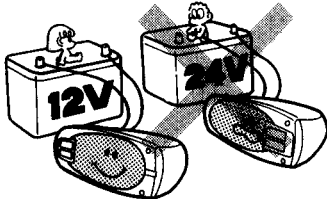

3. Water and moisture — Do not install the speakers in locations which may be subject to water or moisture.

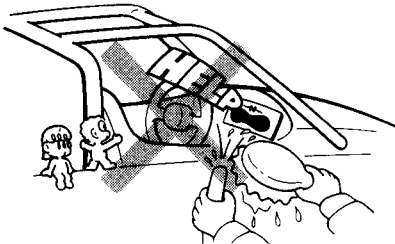

4. Dust and unstable locations — Do not install the speakers in unstable locations or locations subject to dust.

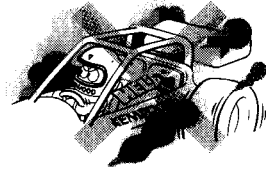

5. Modification — Do not attempt to open or modify the unit, for this could cause fire hazard or malfunction.

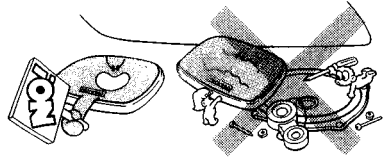

6. Cleaning — Do not use gasoline, naphtha, or any type of solvent to clean the speakers. Clean by wiping with a soft, dry cloth.

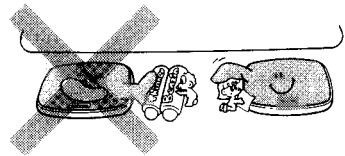

7. Abnormal smell — In the event the unit generates smoke or abnormal smell, immediately switch the power OFF. After this, please contact your dealer or nearest service station as soon as possible.

POWER OFF!

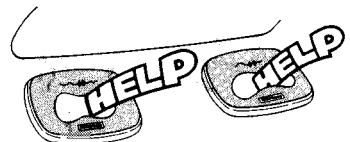

This warranty will be honored only in the U.S.A.

KENWOOD LIMITED WARRANTY FOR CAR STEREO COMPONENTS

HOW LONG IS THE WARRANTY

Kenwood U.S.A. Corporation ("Kenwood") warrants this product for a period of one (1) year from the date of original purchase.

WHAT IS COVERED AND WHAT IS NOT COVERED

Except as specified below, this warranty covers all defects in material and workmanship in Kenwood car stereo components. The following are not covered by the warranty:

1. Any product which is not distributed in the U.S.A. by Kenwood or which is not purchased in the U.S.A. from an authorized Kenwood car stereo dealer or an automobile dealer, unless the product is purchased through the U.S.A. Military Exchange Service.
2. Any product on which the serial number has been defaced, modified or removed.
3. Damage, deterioration or malfunction resulting from:
 - a. Any shipment of the product (claims must be presented to the carrier).
 - b. Installation or removal of the product.
 - c. Accident, acts of nature, misuse, abuse, neglect, unauthorized product modification or failure to follow instructions supplied with the product.
 - d. Repair or attempted repair by anyone not authorized by Kenwood.
 - e. Any other cause which does not relate to a product defect.

WHO IS PROTECTED

This warranty is enforceable only by the original purchaser.

WHAT WE WILL PAY FOR

We will pay for all labor and material expenses for covered items. Payment of shipping charges is discussed in the next section of this warranty.

HOW TO OBTAIN WARRANTY SERVICE

If your KENWOOD product ever needs service:

1. Take or ship it to any KENWOOD Authorized Service Center in the U.S.A. along with a complete description of the problem. (if you are uncertain as to whether a Service Center is authorized, please call 1-800-KENWOOD for the nearest Service Center. 1-800-536-9663).
2. Although you must pay any shipping charges if it is necessary to ship the product for warranty service, we will pay the return shipping charges if the repairs are covered by the warranty within the United States.
3. Whenever your units are taken or sent for warranty service, you must include a copy of the original dated sales receipt as proof of warranty coverage.

LIMITATION OF IMPLIED WARRANTIES

ALL IMPLIED WARRANTIES, INCLUDING WARRANTIES OF MERCHANTABILITY AND FITNESS FOR A PARTICULAR PURPOSE, ARE LIMITED IN DURATION TO THE LENGTH OF THIS WARRANTY.

EXCLUSION OF DAMAGES

KENWOOD'S LIABILITY FOR ANY DEFECTIVE PRODUCT IS LIMITED TO THE REPAIR OR REPLACEMENT OF THE PRODUCT AT OUR OPTION. KENWOOD SHALL NOT BE LIABLE FOR:

1. INSTALLATION OR REMOVAL CHARGES, DAMAGE TO OTHER PROPERTY CAUSED BY ANY DEFECTS IN KENWOOD CAR STEREO COMPONENTS, DAMAGES BASED UPON INCONVENIENCE, LOSS OF USE OF THE PRODUCT; OR
2. ANY OTHER DAMAGES, WHETHER INCIDENTAL, CONSEQUENTIAL OR OTHERWISE.

SOME STATES DO NOT ALLOW LIMITATIONS ON HOW LONG AN IMPLIED WARRANTY LASTS AND/OR DO NOT ALLOW THE EXCLUSION OR LIMITATION OF INCIDENTAL OR CONSEQUENTIAL DAMAGES, SO THE ABOVE LIMITATIONS AND EXCLUSIONS MAY NOT APPLY TO YOU.

This warranty gives you specific legal rights, and you may also have other rights which vary from state to state.

If a problem develops during or after the Limited Warranty Period, or if you have any questions regarding the operation of the product, you should contact your KENWOOD Authorized Dealer or Authorized Service Center. If the problem or your question is not handled to your satisfaction, please contact our Customer Relations Department at the address listed below: